

sanwa®

DCL1200R **DIGITAL CLAMP METER**

INSTRUCTION MANUAL **CE**

Table of Contents

[1] SAFETY PRECAUTIONS – Before use, read the following safety precautions.–	
1-1 Explanation of Warning Symbols	1
1-2 Warning Messages for Safe Use	1
1-3 Overload Protection	2
[2] APPLICATIONS AND FEATURES	
2-1 Applications	3
2-2 Features	3
[3] NAMES AND FUNCTIONS OF COMPONENT UNITS	
3-1 Names and Functions of the Meter and Test Leads	4
3-2 Display	6
[4] DESCRIPTION OF FUNCTIONS AND TERMS	
4-1 Auto Power Off	7
4-2 AC Detection Method	7
4-3 Crest Factor	8
[5] MEASURING PROCEDURE	
5-1 Start-up Inspection	9
5-2 AC Current (ACA) Measurement	10
5-3 Voltage (V) Measurement, Frequency (Hz) Measurement ..	11
5-4 Auto Resistance Voltage Determination (AUTO $\Omega \cdot V$) ..	12
5-5 Resistance/Continuity Check (600 Ω), Diode Test (\rightarrow), Capacitance Measurement (\rightarrow)	14
5-6 Voltage Detection (\oplus EF)	16
[6] MAINTENANCE	
6-1 Maintenance and Inspection	17
6-2 Calibration and Inspection	17
6-3 Storage	17
6-4 Battery Replacement	17
[7] AFTER-SALE SERVICE	
7-1 Warranty and Provision	18
7-2 Repair	19
7-3 SANWA web site	20
[8] SPECIFICATIONS	
8-1 General Specifications	21
8-2 Measuring Range and Accuracy	22

[1] SAFETY PRECAUTIONS

***Before use, read the following safety precautions.**

This instruction manual explains how to use your new digital clamp meter DCL1200R. Before use, please read this manual thoroughly to ensure correct and safe use. After reading it, keep it together with the product for reference to it when necessary.

Using the product in a manner not specified in this manual may cause damage to the protection function of the product.

The instructions given under the heading of “ WARNING” must be followed to prevent accidental burn and electric shock.

1-1 Explanation of Warning Symbols

The meaning of the symbols used in this manual and attached to the product is as follows:

 : **Very important instructions for safe use.**

- The warning messages are intended to prevent accidents to operating personnel such as burn and electric shock.
- The caution messages are intended to prevent incorrect handling and measurement which may damage the product.

 : Risk of Electric shock

 : Direct current (DC)

 : Ground

 : Resistance

 : Alternating current (AC)

 : Diode

 : Buzzer

 : Capacitance

 : Double insulation or reinforced insulation

1-2 Warning Messages for Safe Use

WARNING

The following instructions are intended to prevent personal injury such as burn and electric shock. Be sure to follow them when using the meter:

1. This is a clamp meter for low-voltage circuits. Be sure to use it for circuits of voltage-to-ground of 600 Vrms or below.
2. Voltages above 70 VDC or 33 Vrms AC (46.7 V peak) are hazardous to human body. Never touch them.
3. Never input signals exceeding the maximum rated input value (see 1-3).
4. Never use the meter for measuring voltages of lines connected to equipment (e.g. motors) that generates induced or surge voltage since it may exceed the maximum allowable overload input.

5. Never use the meter near equipment which generates strong electromagnetic waves or is charged.
6. Never use the meter if the meter or test leads are damaged or broken.
7. Never use the meter with the case or battery lid removed.
8. During measurement, do not hold a place beyond the barrier of the meter or the test pin side of the flange of the test leads.
9. To measure a voltage, first connect the black test lead to the negative (-) or ground side. When disconnecting, the positive (+) or non-ground side must be disconnected first.
10. During measurement, do not change the meter to another function.
11. Before starting measurement, make sure that the function and range are properly set.
12. Never use the meter when it is wet or with wet hands.
13. Be sure to use the specified type of test leads.
14. Never attempt repair or modification, except for battery replacement.
15. Inspect the meter at least once a year.
16. This meter is for indoor use only.

1-3 Overload Protection

The maximum rated input value and overload protection have been established for the signal input part of each function.

Function	Signal Input Part	Maximum Rated Input Value	Maximum Overload Protection
A	Clamp type current sensor (CT)	AC 1200 Arms	AC 2000 Arms
V·Hz AUTO Ω·V	Between + and - terminal	DC·AC 600 Vrms	DC·AC 600 Vrms
600Ω ⚡		 Voltage and current input prohibited.	

[2] APPLICATIONS AND FEATURES

2-1 Applications

This is an AC clamp meter designed for the IEC measurement category CAT. III 600 V and is suitable for measurement of AC current of electrical equipment and power supply facilities.

2-2 Features

- Lighter than conventional clamp meters (30 % reduction from Sanwa equivalent meters) for easy transportation.
- TRUE RMS (AC coupling)
- Large "HOLD" button to ensure holding of the indicated value.
- Safety design in compliance with the IEC.
- Auto resistance/voltage determination function is available.
- Non-contact voltage detection function.
- Fast response continuity buzzer (<100 μ s).
- Back light
- DMM function provided.

PER IEC61010 OVERVOLTAGE INSTALLATION CATEGORY OVERVOLTAGE CATEGORY II

Equipment of OVERVOLTAGE CATEGORY II is energy-consuming equipment to be supplied from the fixed installation.

Note :

Examples include household, office, and laboratory appliances.

OVERVOLTAGE CATEGORY III

Equipment of OVERVOLTAGE CATEGORY III is equipment in fixed installations.

Note :

Examples include switches in the fixed installation and some equipment for industrial use with permanent connection to the fixed installation.

OVERVOLTAGE CATEGORY IV

Equipment of OVERVOLTAGE CATEGORY IV is for use at the origin of the installation.

Note :





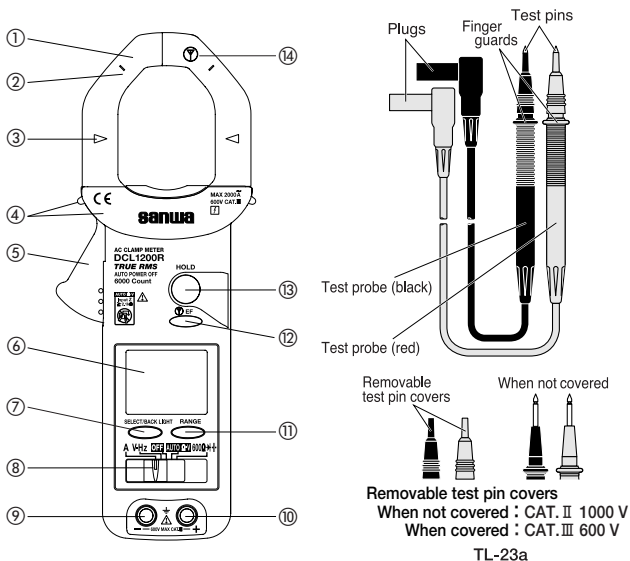

Examples include electricity meters and primary over-current protection equipment.

[3] NAMES AND FUNCTIONS OF COMPONENT UNITS

3-1 Names and Functions of the Meter and Test Leads



①	Clamp type current sensor (CT)	A sensor to clamp a conductor to measure. ("Clamp sensor")
②	Accuracy guarantee range mark	A range to clamp a conductor to measure which is guaranteed for accuracy. (See 5-2)
③	Center position mark	
④	Barrier	A convex part to prevent fingers from touching an object to measure during measurement of current.
⑤	Open/close lever	A lever to open and close the clamp sensor.
⑥	Display	An LCD to show measured values.

⑦	SELECT/ BACK LIGHT button	<p>When this button is pressed, the functions change as follows: V · Hz Position : DCV → ACV → Hz → DCV 600Ω →  Position : 600 Ω →  →  → 600 Ω</p> <p>BACKLIGHT function : When the button is held pressed for 1 second or longer, the backlight of the LCD will be turned on. When the button is held pressed for 1 second or longer again, the backlight will be turned off. It will also be turned off when the function switch is set to OFF. It will not turn off automatically.</p>
⑧	Power switch & function switch	Slide this switch to turn on and off the power and to select a function.
⑨	– measuring terminal	Insert the black test lead.
⑩	+ measuring terminal	Insert the red test lead.
⑪	RANGE button (Range hold)	<p>When the RANGE button is pressed, the meter will be set in the manual mode and the range will be fixed. (“AUTO” will disappear from the display.) In the manual mode, each time this button is pressed, the range changes. While checking the unit and decimal point on the display, select the best range. To return to the auto range, hold this button pressed for 1 second or longer. (“AUTO” will appear on the display.) Note: During frequency measurement (Hz) and capacitance measurement () , it cannot be changed to the manual range.</p>
⑫	EF button (Voltage detection)	When this button is pressed with the function switch in positions other than OFF, “E.F” will be shown in the display to activate the non-contact and contact type voltage detection functions. “-” is shown in the display and buzzer sounds on the charging circuit side (non-ground side) of the line.
⑬	HOLD button (Data hold)	When this button is pressed, the indicated value will be held. (“  ”) will appear on the display.) The indicated value will not change if the measurement input fluctuates. When this button is pressed again, the hold status will be canceled and the meter will return to the normal measurement mode. (“  ”) will disappear from the display.)
⑭		Sensor position for non-contact voltage detection.

3-2 Display

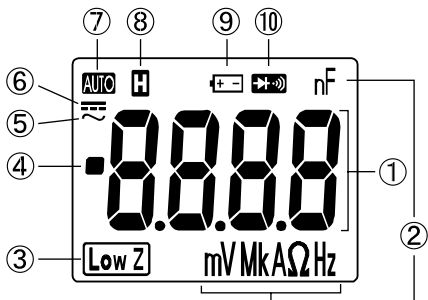

①		Numerical value indication.
②		Unit of measurement.
③		Lights during voltage measurement of low-input impedance by AUTO V·Ω function.
④		Negative sign of numerical data.
⑤		Indication of AC measurement.
⑥		Indication of DC measurement.
⑦		Lights in the auto range mode.
⑧		Lights in the data hold mode.
⑨		Warning of low battery power: This mark will appear on the display when the built-in battery has been discharged and its voltage has dropped to below about 2.4 V. When this mark flickers or lights, replace the battery with a new one.
⑩		Lights during diode test.

[4] DESCRIPTION OF FUNCTIONS AND TERMS

4-1 Auto Power Off

About 3~7 minutes after power on, the power will automatically be turned off and the display will become blank. However, if any of the following events occurs, the power will be turned off about 3~7 minutes after such event:

- Indication other than "OL" at $600\Omega \rightarrow \text{H}$.
- Indication other than "AUTO" at **AUTO** $\Omega \cdot V$.
- Indication other than 0 at Hz.
- Fluctuation more than 10 % at DCV, ACV and A.
- Operation of the function switch or other button.

To reset the meter, press any button or remove the test leads or the clamp sensor (CT) from an object to measure and set the function switch to OFF.

*In the auto power off mode, a very small amount of current keeps flowing. Therefore, when measurement has been finished, be sure to return the function switch to the OFF position.





*The auto power off function cannot be canceled.

4-2 AC Detection Method

This meter employs the root-mean-square value method and indicates the magnitude of AC as the same amount of work as DC. Root-mean-square values of sinusoidal waves and such non-sinusoidal waves as square waves and chopping waves can be measured by the true RMS (Root Mean Square) circuit. (The measured value of input signals is the measure of actual input signal power and therefore, more effective values can be obtained than averaged values.)

4-3 Crest Factor

The CR (crest factor) indicates the peak value of a signal by dividing it by its root-mean-square value. With most common waveforms such as sinusoidal wave and chopping wave, the crest factor is relatively low. With waveforms similar to low duty cycle pulse trains, the crest factor is high. For the voltages and crest factors for typical waveforms, see the table below.

Input Waveform	Peak V_p	RMS V_{rms}	Average V_{avg}	CF V_p/V_{rms}	Form Factor V_{rms}/V_{avg}
Sine Wave 	V_p	$\frac{V_p}{\sqrt{2}}$ $=0.707 V_p$	$\frac{2 V_p}{\pi}$ $=0.637 V_p$	$\sqrt{2}$ $=1.414$	$\frac{\pi}{2\sqrt{2}}$ $=1.111$
Square Wave 	V_p	V_p	V_p	1	1
Triangular Wave 	V_p	$\frac{V_p}{\sqrt{3}}$ $=0.577 V_p$	$\frac{V_p}{2}$ $=0.5 V_p$	$\sqrt{3}$ $=1.732$	$\frac{2}{\sqrt{3}}$ $=1.155$
Puls 	V_p	$\sqrt{\frac{\tau}{2\pi}} \cdot V_p$	$\frac{\tau}{2\pi} \cdot V_p$	$\sqrt{\frac{2\pi}{\tau}}$	$\sqrt{\frac{2\pi}{\tau}}$

Voltages of Various Waveforms

[5] MEASURING PROCEDURE

⚠ WARNING

1. Do not apply an input signal exceeding the maximum rated input of each function.
2. During measurement, do not change the function switch.
3. During measurement, do not hold a place beyond the barrier of the meter or the test pin side of the flange of the test leads.
4. When measurement has been finished, remove the clamp sensor (CT) and test leads from the object measured and return the function switch to the **OFF** position.

5-1 Start-up Inspection

⚠ CAUTION

1. Be sure that when the power switch is turned on, the battery low warning mark () is not flickering or lit. If it is flickering or lit, replace the battery with a new one. (See 6-4.)
2. Do not use the meter if the meter or test lead is damaged or broken.
3. Make sure the test leads are not cut.

Always conduct the start-up inspection to ensure safety.

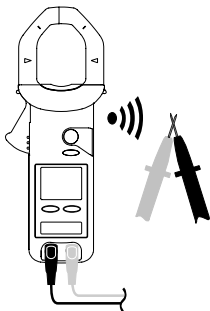
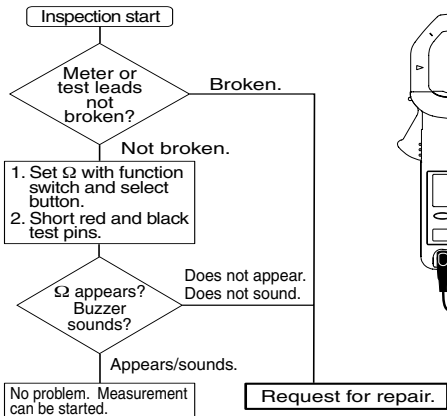

5-2 AC Current (ACA) Measurement

⚠ WARNING

Remove the test leads from the measuring terminals to avoid electric shock.

Function	Maximum Rated Input Value	Range
ACA	AC 1200 A	400.0 A, 1200 A

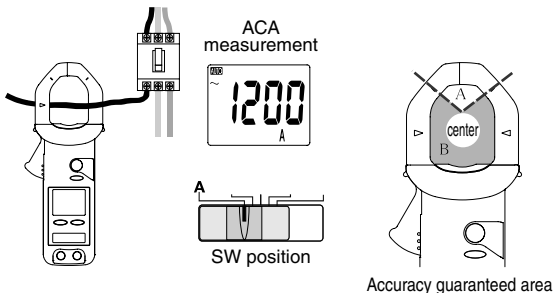

Remarks:

- This meter is of true RMS sensing (AC coupling). The accuracy guarantee range is as follows:
Frequency range: 50/60 Hz
Crest factor (CF) range: Full scale CF < 2.0, Half scale CF < 4.0
Accuracy is specified from 5 % to 100 % of ranges.
- If vibration noise occurs in the clamp sensor (CT) part when measuring a large current above 100 A, it is not a failure.
- For accuracy when the indicated value is 10 % of the range or less, 8 dgt is added to the accuracy shown in 8-2.
- An induction error below 0.06 A/A may occur due to influence of current flowing in adjacent conductors.
- A guide for a range of conductor positions for accuracy guarantee
When an object is measured at the center of the clamp sensor (CT), the specified accuracy (see 8-2) can be obtained. In other places of conductors to be measured, the accuracy is as follows:
A area: 4 % is added to the specified accuracy.
B area: 1 % is added to the specified accuracy.

5-3 Voltage (V) Measurement, Frequency (Hz) Measurement

Function	Maximum Rated Input Value	Range
ACV, DCV	600 V	6.000 V(6000 mV), 60.00 V, 600.0 V

Function	Voltage range	Sensitivity (Sinusoidal wave RMS)	Frequency Measurement Range
Hz	6.000 V	Approx. 4 V	10 Hz ~ 30 kHz
	60.00 V	Approx 30 V	10 Hz ~ 1 kHz
	600.0 V	Approx 60 V	10 Hz ~ 1 kHz

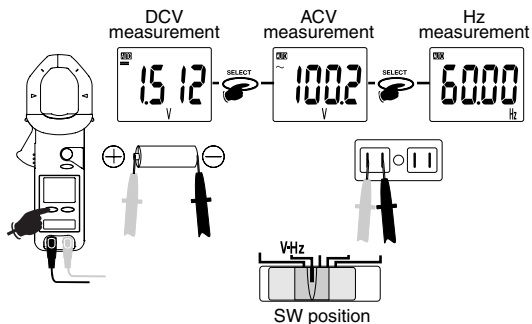

Remarks:

- Voltage (ACV & DCV) function
 - The input resistance is 5 M Ω
 - The indication may be fluctuated at 6.000 V (6000 mV) range when open circuit.
 - 5 counts might be displayed even it short-circuits.
 - “-” signs appear if “+” and “-” polarity are measured reversing at the DCV measurement.
- ACV function (AC coupling, True RMS)
 - The accuracy guarantee range: In between 5 ~ 100 % of measuring range
 - Crest Factor (CF) range: Full scale CF < 1.6
Half scale CF < 3.3
- Frequency range: 50 – 500 Hz
- Frequency measurement
 - Measurement sequence(Max. count : 9999)
Apply ACV at first, and then shift to Hz function in order to select reasonable input sensitivity automatically.

5-4 Auto Resistance Voltage Determination (AUTO $\Omega \cdot V$)

⚠ WARNING

Because the initial input resistance is as low as 2.1 k Ω , a very large amount of current will flow. Never use the meter for measuring circuits or devices having a small current capacity. For measurement of voltages that requires high input resistance, use the V function of V.Hz (input impedance 5 M Ω).

Function	Maximum Rated Input Value	Range
Ω	6 M Ω	6.000 k Ω , 60.00 k Ω , 600.0 k Ω , 6.000 M Ω
DCV	DC 600 V	6.000 V (6000 mV), 60.00 V, 600.0 V
ACV	AC 600 V	6.000 V (6000 mV), 60.00 V, 600.0 V

- This function enables measurement by automatically determining whether the input is resistance (Ω) or voltage (V) and whether the voltage is ACV or DCV.
- When a voltage is indicated when measuring resistance, you can know a voltage is present.
- Because of low input resistance (Low-Z), voltage measurement is unlikely to be affected by an induced voltage in adjacent cables, and therefore, the meter is useful for measuring voltages in areas where cables are congested.

Resistance (Ω) and voltage (V) automatic determination

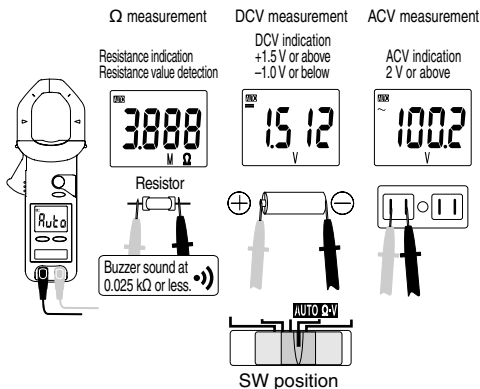

Remarks:

- When there is no input, “**AUTO**” will be shown. When the RANGE button is pressed, the manual Ω function will be set.
- When there is no voltage input, a resistance value up to 6 M Ω will be shown. When the **RANGE** button is pressed in this state, the manual range of the Ω function will be set (“**AUTO**” will disappear). If a voltage is applied, the meter will not change to the voltage measuring function.
- If the RANGE button is pressed in the voltage measuring function, the manual range of either the DCV or ACV function will be set (“**AUTO**” will disappear). If a resistor is connected in this state, the meter will not change to the resistance measuring function.
- The buzzer sounds when the resistance value is below about 0.025 k Ω (25 Ω).
- When the DC voltage is above +1.5 V or below -1 V, the DCV value is automatically indicated. In case of negative value, “-” polarity is displayed. (“**---**” & **Low Z**) will appear.)
- When the AC voltage is above 2 V, the ACV value is automatically indicated (“**~**” & **Low Z**) will appear).
- Either a DCV or ACV value whichever is higher is indicated.
- When there is an input above 600 V, “OL” is indicated and the buzzer sounds. Immediately remove the test leads from the object being measured and stop measurement.
- Measurement of voltages in circuits having high internal impedance shows a lower value than the actual value due to voltage drop.
- When the RANGE button is pressed once, the function (Ω , DCV or ACV) being used and the range will be fixed and “**AUTO**” will disappear. When the button is pressed again in this state, the range can be changed. When the button is held pressed for 1 second or longer, “**AUTO**” will appear again and the meter will return to the **AUTO** Ω -V mode.
- To measure resistance after measuring 50 V or over, wait 2 minutes before starting measurement.

5-5 Resistance/Continuity Check (600 Ω), Diode Test (\rightarrow †), Capacitance Measurement (†)

WARNING

Never apply a voltage to the input terminals.

5-5-1 Resistance measurement / Continuity check (600 Ω)

Function	Maximum Rated Input Value	Range
Resistance measurement Continuity check	600 Ω	600.0 Ω

Remarks:

- Buzzer response speed: <100 μ s
- Buzzer sound range: 0 Ω ~ 155 Ω (\pm 145 Ω)
- Open circuit voltage: Approx. 0.4 VDC
- For less than 20 % of the range (0.0 Ω ~ 120.0 Ω), 40 dgt is added to the accuracy (see 8-2).

5-5-2 Diode test (\rightarrow †)

Open circuit voltage: Approx. 1.6 VDC

Measuring current: 0.4 mA (typical)

Diodes under voltage cannot be tested.

5-5-3 Capacitance measurement (†)

CAUTION

1. Be sure to remove electric charge in the capacitor before measurement.
2. Because this meter applies a current to the capacitor to measure, it is not suitable for measurement of electrolytic capacitors having a large leak current as a large error will occur.
3. For capacitors having large capacitance, measurement takes a longer time.
 - 100 μ F: About 10 seconds
 - 500 μ F: About 30 seconds
 - 1000 μ F: About 50 seconds
4. Please note that the measuring value is unexpected when measuring a capacitor which is punctured or with bad isolation capability.

Function	Maximum Rated Input Value	Range
Capacitance(μ)	2000 μ F	100.0 nF, 1000 nF, 10.00 μ F, 100.0 μ F, 2000 μ F

Remarks:

• 50.00 nF or below is out of the accuracy guarantee range.
 The accuracy drops to $\pm(12\% \text{ rdg} + 8 \text{ dgt})$ when the power supply voltage is in a range of 2.8 V and about 2.4 V (out of accuracy guarantee range) at which the battery low mark will light.

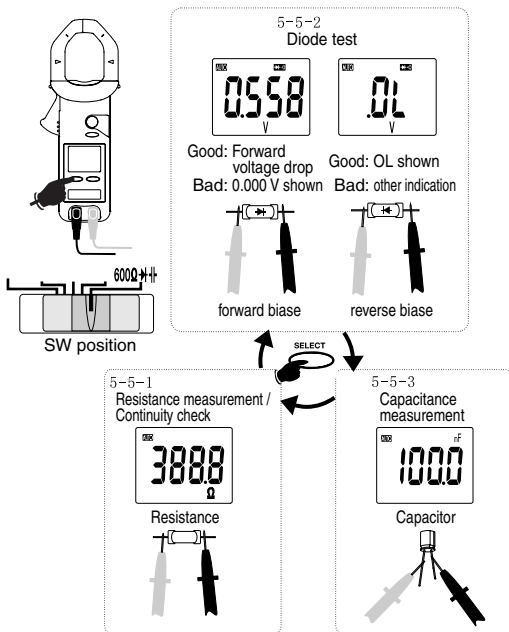

Each time the **SELECT** button is pressed, the functions change as indicated by \rightarrow in the figure.

5-6 Voltage Detection (Ⓢ EF)

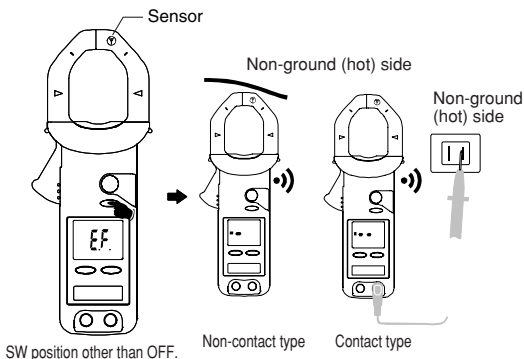

Remarks:

- In any function switch position other than OFF, when the EF button is pressed, "E.F." will be shown in the display and voltage detection can be started.
- Voltage Detection measurement.
 - Non-contact type: Bring Ⓢ marked part of clamp sensor into contact with an object to be measured.
 - contact type: Bring a test pin, which is connected to "+" measurement terminal, into contact with an object to be measured.
- On the charging side (non-ground side), the following "-" is shown and the buzzer sounds. On the ground side, "E.F." remains shown and the buzzer does not sound.
- If the (Ⓢ) mark part of the clamp sensor touches an enclosure of ungrounded equipment, "-" may be shown and the buzzer may sound.
- Input sensitivity : Approx. 20 V or over

[6] MAINTENANCE

WARNING

1. The following instructions are very important for safety. Read this manual thoroughly to ensure correct maintenance.
2. Calibrate and inspect the meter at least once a year to ensure safety and maintain its accuracy.

6-1 Maintenance and Inspection

- 1) Appearance: Is the meter not damaged due to falling or other cause?
- 2) Test leads: Are the test leads not damaged, or is the core wire not exposed from any part or broken?
If any of the above problems exists, stop using the meter and request for repair.

6-2 Calibration and Inspection

For more information, please contact your dealer or Sanwa agent.

6-3 Storage

CAUTION

1. The panel and case are not resistant to volatile solvent and must not be cleaned with thinner or alcohol.
2. The panel and case are not resistant to heat. Do not place the meter near heat-generating devices.
3. Do not store the meter in a place where it may be subjected to vibration or from where it may fall.
4. Do not store the meter in places under direct sunlight, or hot, cold or humid places or places where condensation is anticipated.
5. If the meter will not be used for a long time, remove the battery.

6-4 Battery Replacement

Battery when the meter is shipped:

A battery for monitoring has been installed prior to shipment from the factory. It may be discharged before the expiration of the described battery life.

- * The battery for monitoring is a battery used to check the functions and performance of the product.

⚠ **WARNING**

If the rear case is removed with an input being applied to the measuring terminals, you may suffer electric shock. Before starting replacement, always make sure no input is being applied and the function switch is OFF.

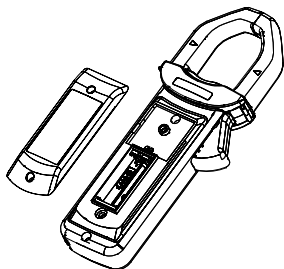

- (1) Remove the battery lid screws (2 pieces) with a screwdriver.
- (2) Take out the battery and replace it with a new one.
Battery: R03 (AAA)
1.5 V x 2 pieces
- (3) Attach the battery lid and secure it with screws.

[7] AFTER-SALE SERVICE

7-1 Warranty and Provision

Sanwa offers comprehensive warranty services to its end-users and to its product resellers. Under Sanwa's general warranty policy, each instrument is warranted to be free from defects in workmanship or material under normal use for the period of one (1) year from the date of purchase.

This warranty policy is valid within the country of purchase only, and applied only to the product purchased from Sanwa authorized agent or distributor.

Sanwa reserves the right to inspect all warranty claims to determine the extent to which the warranty policy shall apply. This warranty shall not apply to disposables batteries, or any product or parts, which have been subject to one of the following causes:

1. A failure due to improper handling or use that deviates from the instruction manual.
2. A failure due to inadequate repair or modification by people other than Sanwa service personnel.
3. A failure due to causes not attributable to this product such as fire, flood and other natural disaster.
4. Non-operation due to a discharged battery.
5. A failure or damage due to transportation, relocation or dropping after the purchase.

7-2 Repair

Customers are asked to provide the following information when requesting services:

1. Customer name, address, and contact information
2. Description of problem
3. Description of product configuration
4. Model Number
5. Product Serial Number
6. Proof of Date-of-Purchase
7. Where you purchased the product

Please contact Sanwa authorized agent / distributor / service provider, listed in our website, in your country with above information. An instrument sent to Sanwa / agent / distributor without above information will be returned to the customer.

Note :

- 1) Prior to requesting repair, please check the following:
Capacity of the built-in battery, polarity of installation and discontinuity of the test leads.
- 2) Repair during the warranty period:
The failed meter will be repaired in accordance with the conditions stipulated in 7-1 Warranty and Provision.
- 3) Repair after the warranty period has expired:
In some cases, repair and transportation cost may become higher than the price of the product. Please contact Sanwa authorized agent / service provider in advance.
The minimum retention period of service functional parts is 6 years after the discontinuation of manufacture. This retention period is the repair warranty period. Please note, however, if such functional parts become unavailable for reasons of

discontinuation of manufacture, etc., the retention period may become shorter accordingly.

4) Precautions when sending the product to be repaired:

To ensure the safety of the product during transportation, place the product in a box that is larger than the product 5 times or more in volume and fill cushion materials fully and then clearly mark "Repair Product Enclosed" on the box surface. The cost of sending and returning the product shall be borne by the customer.

7-3 SANWA web site

<http://www.sanwa-meter.co.jp>

E-mail: exp_sales@sanwa-meter.co.jp

[8] SPECIFICATIONS

8-1 General Specifications

Operation method	$\Delta-\Sigma$ method
AC Sensing	True RMS AC coupling
LCD	6000 counts
Sampling rate	5 times/sec nominal
Range selection	Auto and Manual
Over-range indication	"OL" shown in numerical part.
Polarity indication automatic selection	"-" indicated only when negative input.
Low battery indication	"  " lights or flickers at about 2.4 V or below.
Environmental condition	Altitude 2000 m or below, pollution degree II.
Operating temperature / humidity	5 °C to 40 °C and maximum relative humidity 80 % for temperature up to 31 °C decreasing linearly to 50 % relative humidity at 40 °C (No condensation)
Storage temperature / humidity	-20 °C ~ 60 °C, 70 %R.H or below (with battery removed).
Power supply	R03 1.5 V x 2 pieces
Power consumption	2.8 mA at DCV (typical)
Battery life	Approx. 90 hours at DCV (Disable Auto power off)
Safety standards	IEC61010-1, IEC61010-2-032, IEC61010-2-033 CAT.III 600 V IEC61010-031
EMC	IEC61326 In an RF field of 3 V/m: Total Accuracy = Specified Accuracy + 45 digits Performance above 3 V/m is not specified
Clamp sensor (CT) clamp size	Max. 42 mm
Dimensions	238(L) X 95(W) X 45(H) mm
Mass	Approx. 290 g (battery included)
Auto power off	About 3~7 min. after power on.
Accessories	Battery (built-in), Test leads (TL-23a), Carrying case (C-DCL1000), Instruction manual

8-2 Measuring Range and Accuracy

Temperature: 23±5 °C, humidity: 75 % RH max., built-in battery voltage 2.4 V or above.
rdg (reading): Read value, dgt (digit): Number of counts of last digit

ACA (True RMS AC coupling)

Range	Accuracy
400.0 A	±(1.7 %rdg+5dgt)
1200 A	

Remarks:

- This meter is of True RMS sensing.
Frequency range: 50/60 Hz (Sinusoidal wave AC)
Crest Factor (CF): Full scale CF < 2.0, Half scale CF < 4.0
Accuracy is specified from 5 % to 100 % of ranges.
- Accuracy is specified when an object is measured at the center of the clamp sensor (CT),
- A guide for a range of conductor positions for accuracy guarantee
In other places of conductors to be measured, the accuracy is as follows:
A zone: 4 % is added to the specified accuracy.
B zone: 1 % is added to the specified accuracy.
- For accuracy when the indicated value is 10 % of the range or less, 8 dgt is added to the accuracy.
- An induction error below 0.06 A/A may occur due to influence of current flowing in adjacent conductors.

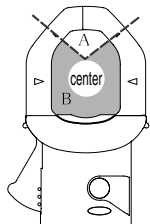

DCV

Range	Accuracy	Input Impedance	Remarks
6.000 V	±(0.7 %rdg+3dgt)	Approx. 5 MΩ	
60.00 V	±(1.2 %rdg+5dgt)		
600.0 V	±(2.2 %rdg+5dgt)		

ACV (True RMS AC coupling)

Range	Frequency range	Accuracy	Input Impedance
6.000 V	50 Hz/60 Hz	$\pm(1.7\%rdg+5dgt)$	Approx. 5 M Ω
	50 Hz~500 Hz	$\pm(2.2\%rdg+5dgt)$	
60.00 V	50 Hz/60 Hz	$\pm(1.7\%rdg+5dgt)$	
	50 Hz~500 Hz	$\pm(2.2\%rdg+5dgt)$	
600.0 V	50 Hz/60 Hz	$\pm(2.2\%rdg+5dgt)$	
	50 Hz~500 Hz	$\pm(2.7\%rdg+5dgt)$	

Remarks:

- Frequency range: 50 Hz~500 Hz
- The accuracy guarantee range: In between 5 ~ 100 % of measuring range
- Crest Factor (CF): Full scale CF < 1.6, Half scale CF < 3.3

Frequency Hz

Voltage Range	Sensitivity (Sine wave)	Frequency Measurement Range
6.000 V	4 V	10 Hz ~30 kHz
60.00 V	30 V	10 Hz ~ 1 kHz
600.0 V	60 V	10 Hz ~ 1 kHz

Accuracy: $\pm(0.6\%rdg+4dgt)$

AUTO Ω · V

Range	Accuracy	Frequency range	
6.000 k Ω	$\pm(1.4\%rdg+6dgt)$		
60.00 k Ω	$\pm(1.2\%rdg+4dgt)$		
600.0 k Ω			
6.000 M Ω	$\pm(2.2\%rdg+4dgt)$		
DC 6.000 V	$\pm(0.7\%rdg+3dgt)$		
DC 60.00 V	$\pm(1.2\%rdg+5dgt)$		
DC 600.0 V	$\pm(2.2\%rdg+5dgt)$		
AC 6.000 V	$\pm(1.7\%rdg+5dgt)$		50 Hz/60 Hz
	$\pm(2.2\%rdg+5dgt)$		50 Hz~500 Hz
AC 60.00 V	$\pm(1.7\%rdg+5dgt)$		50 Hz/60 Hz
	$\pm(2.2\%rdg+5dgt)$	50 Hz~500 Hz	
AC 600.0 V	$\pm(2.2\%rdg+5dgt)$	50 Hz/60 Hz	
	$\pm(2.7\%rdg+5dgt)$	50 Hz~500 Hz	

Remarks:

- The accuracy guarantee range of ACV: In between 5 ~ 100 % of measuring range.

- The initial internal resistance is about 2.1 k Ω and at an input above 50 V, the internal resistance increases rapidly.
A guide for input voltages and internal resistance:
100 V: 15 k Ω
300 V: 100 k Ω
600 V: 210 k Ω
- Input is detected in the order of Ω , DCV and ACV.
- DCV threshold: 1.5 VDC or above and -1.0 VDC or below.
- ACV threshold: 2 VAC (50/60 Hz) or above.
- Either a DCV or ACV value whichever is higher is shown.
- Crest factor (CF): Full scale CF < 1.6, Half scale CF < 3.3

To measure resistance after measuring 50 V or over, wait 2 minutes before starting measurement.

Resistance / Continuity check (600 Ω)

Range	Accuracy	Remarks
600.0 Ω	$\pm(2.2\% \text{rdg} + 8 \text{dgt})$	<ul style="list-style-type: none"> • Buzzer response speed: < 100 μs • Buzzer sound range: 0 Ω ~ 155 Ω ($\pm 145 \Omega$) • Open circuit voltage: Approx. 0.4 VDC • 40 dgt is added to the accuracy for 20 % or less of the range.

Diode test (→|←)

Open circuit voltage: Approx. 1.6 VDC

Test current: 0.4 mA (typical)

Capacitance measurement (⇄)

Range	Accuracy	Remarks
100.0 nF	$\pm(3.7\% \text{rdg} + 5 \text{dgt})$	<ul style="list-style-type: none"> • Auto range only. • 50.00 nF or below out of accuracy guarantee range. • Accuracy for measurement of film capacitors or similar devices having little leak current. • The accuracy drops to $\pm(12\% \text{rdg} + 8 \text{dgt})$ when the power supply voltage is in a range of 2.8 V and about 2.4 V (out of accuracy guarantee range) at which the battery low mark will light.
1000 nF		
10.00 μF		
100.0 μF		
2000 μF		

Voltage detection EF

Remarks:

- Frequency: 50 Hz/60 Hz
- Detection sensor: () mark part of clamp sensor (CT)
- Voltage detection with test lead connected to + measuring terminal possible.
- Input sensitivity : Approx. 20 V or over

sanwa®

三和電気計器株式会社

本社=東京都千代田区外神田2-4-4・電波ビル

郵便番号=101-0021・電話=東京(03)3253-4871(代)

大阪営業所=大阪市浪速区恵美須西2-7-2

郵便番号=556-0003・電話=大阪(06)6631-7361(代)

SANWA ELECTRIC INSTRUMENT CO.,LTD.

Dempa Bldg., 4-4 Sotokanda2-Chome Chiyoda-Ku,Tokyo,Japan



大豆インキを使用しています。
This manual employs soy ink.

04-1307 2040 6010